

# *Twin*

---

## **Big Volume Guns**

for Travellers, Pivots and Solid-sets

---



---

**THE ADVANTAGE:**

INNOVATION WITH IMPACT

# Twin

While conceiving new products, we must make sure that they meet the values in which we strongly believe: quality, reliability and a solid advantage to the customer. The quality of a product is a reflection of what the people who create, manufacture and market it, stand for. This approach to our work is very important to us.

Reliability is achieved by using the most suitable and functional materials for the intended purpose as well as implementing the strictest quality controls in every step throughout the manufacturing process of our products. The advantage to the customer is found in our efforts to offer products of highest quality and reliability combined with innovative features that we implement in all of them.

The Twin big volume sprinklers represent our capacity to integrate innovative technology, performance and reliability.

Vari-Angle System (Optional) - Patented

Automatic brake system - Patented

Multi pitch flange

Large barrel cross section

High performance nozzle

Dynamic jet-breaker (Optional) - Patented

Innovative drive system - Patented

Low inertia drive arm

Intuitive part-circle setting



Solid-set Systems



Dust Control



Sport Fields



Log Irrigation



Effluent Water



Feed Lots



Travellers



Pivot Systems



**Optimal performance in various applications**

A high-pressure water spray nozzle is shown in the bottom left corner, emitting a powerful, wide fan of water that fills most of the frame. The water droplets are captured in motion, creating a soft, ethereal glow against a dark, textured background.

# Operating Cost VS Purchase Cost

A trend has been developing in the past few years in which the purchase cost of a product has become the most important factor when purchasing equipment. This trend has changed the scope of many companies, moving to a short term market approach that focuses on the purchase cost instead of its real operating cost. We are firmly convinced that our customers generate greater benefit by optimizing the operating cost of the products they use. Our priorities when developing products are to make sure that they are the most reliable, always operate at the optimum efficiency, are easy to use and minimize the waste of precious natural resources. It is surely less demanding and more economically feasible to concentrate a company's product lines with the short term market approach, but we believe that the credibility of our brand is based on the long term quality and performance of our products, and more importantly the return on investment our customers can realize.

# The Advantages

**1.**  
WATER DISTRIBUTION

**2.**  
THROW

**3.**  
ENERGY EFFICIENCY

**4.**  
RELIABILITY

**5.**  
ADAPTABILITY

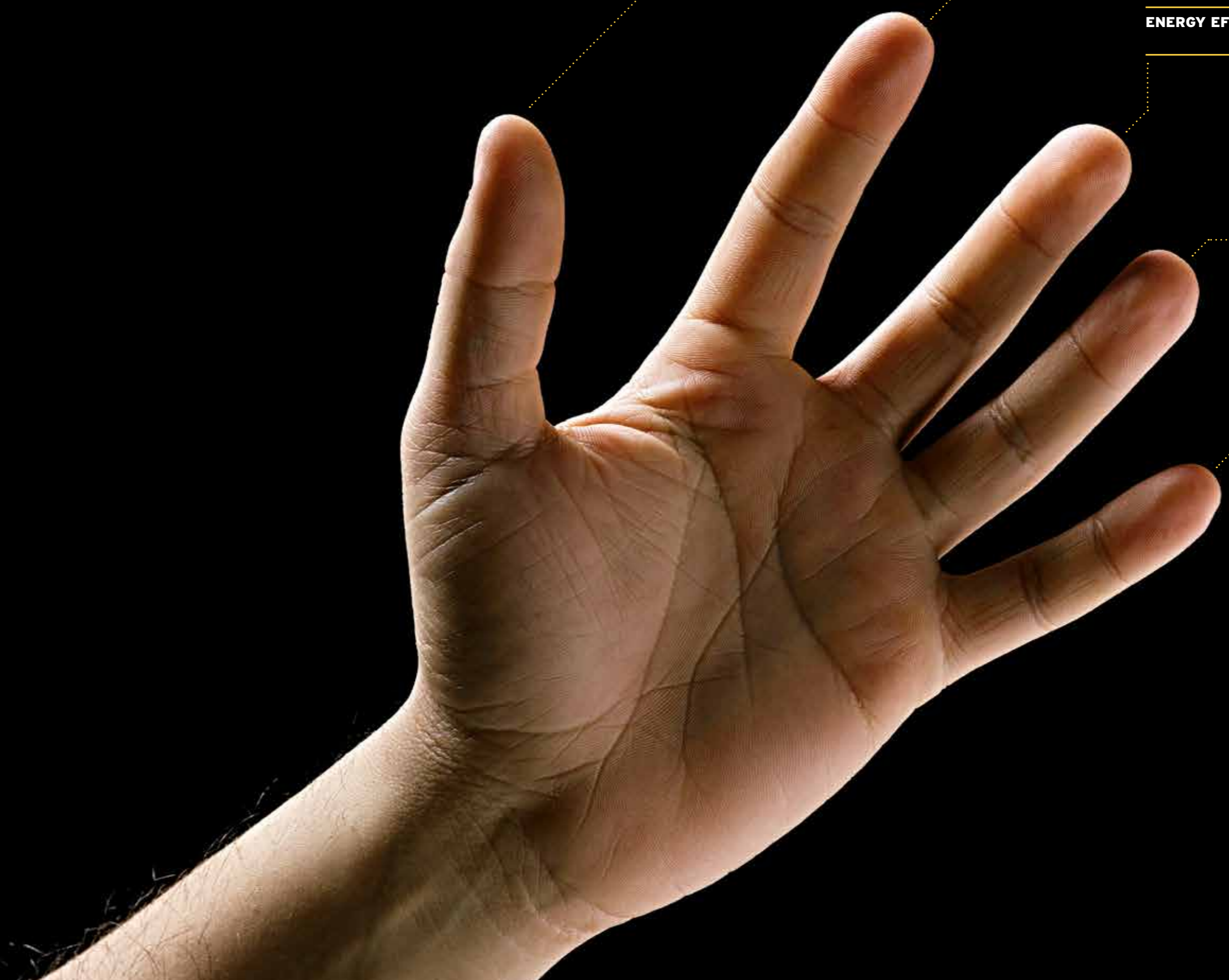

**1**

**Distribution**



# 1 Distribution





Efficient irrigation is an important factor to support crop growth. A uniform water distribution helps the soil to evenly absorb the water, consequently avoiding water run-offs. This greatly promotes even plant growth throughout the field and at the same time can increase the yield and its quality. A fine water application also allows to grow sensitive crops.

## Automatic Brake

This mechanism is designed to allow the gun to maintain a constant rotation speed in all arising operating conditions independently of the prevailing pressure and flow levels.

 Self-adjusted brake force  
→ Ideal rotation speed at all pressures

 Brake force too high  
→ Rotation speed too slow

 Brake force too low  
→ Rotation speed too fast

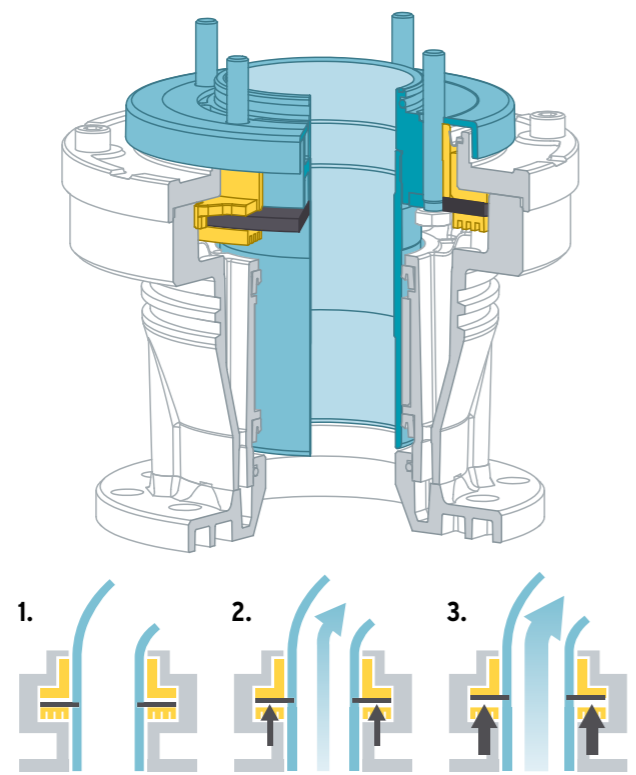

## Automatic brake system

1. While waiting to operate the gun's brake disc rests on the lower brake pads.
2. With increasing operating pressure, the brake disc is pushed upwards against the upper brake pads, generating a braking force.
3. A higher operating pressure will generate a higher brake force to compensate for the increased rotation force produced by the drive system.

## Deflector

This innovative device is capable of distributing the water uniformly, starting from the gun over its entire throw range. The technology and fluid dynamic elements designed into this component let the deflector adapt its operation to all pressure levels and upcoming changes.

### Deflector in action



### Deflector in action / Deflector en función



### Deflector at start-up / Deflector en fase de arranque



**2** | **Throw  
Alcance**

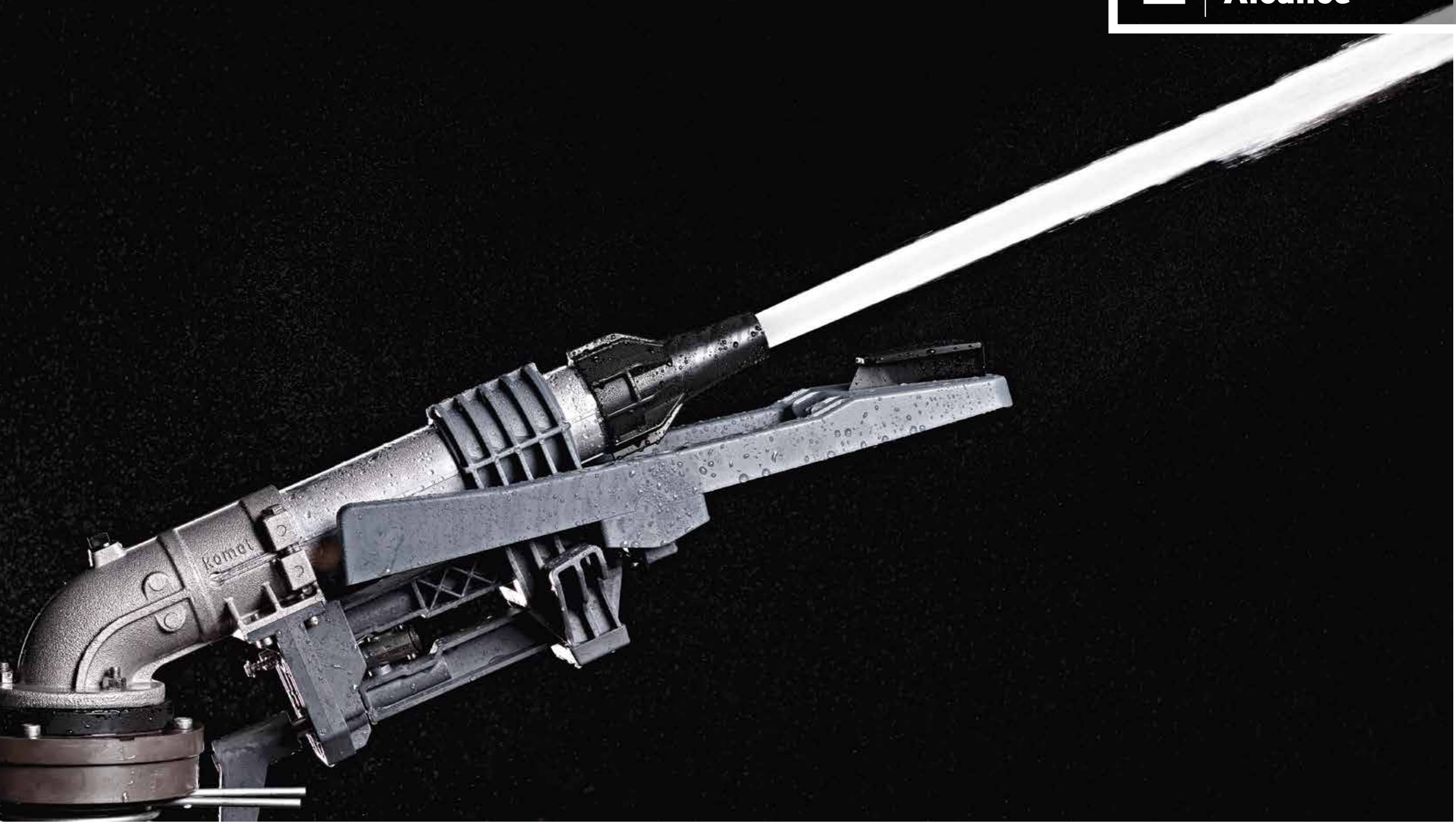



# 2 Throw / Alcance

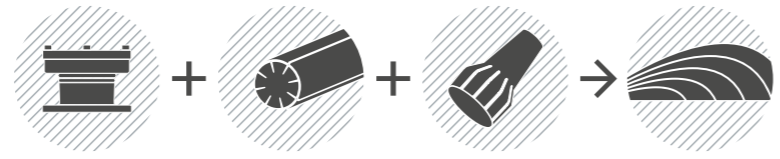

The length of the throw determines the area being irrigated. A longer throw increases the area covered by the irrigation with the effect of making the irrigation more cost effective. At the same time a longer throw determines also a reduction of the instantaneous water application rate thus improving the water take-in of the soil.

## Fluid Dynamics

While in operation the deflector is designed to minimize the oscillation originating from the interaction with the water stream. This is fundamental in order to obtain a laminar water stream exiting the nozzle generating unrivaled throw values.

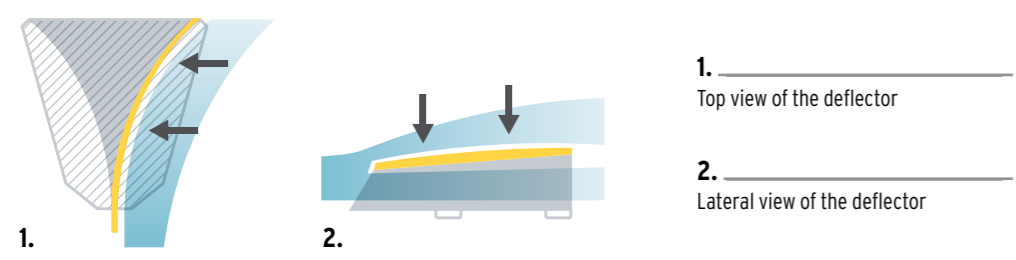

## Barrel

The configuration of the barrel and its internal straightening vanes has been optimized with the use of the most advanced hydraulic simulation software allowing the water to reach the nozzle with the least possible turbulences and pressure losses.

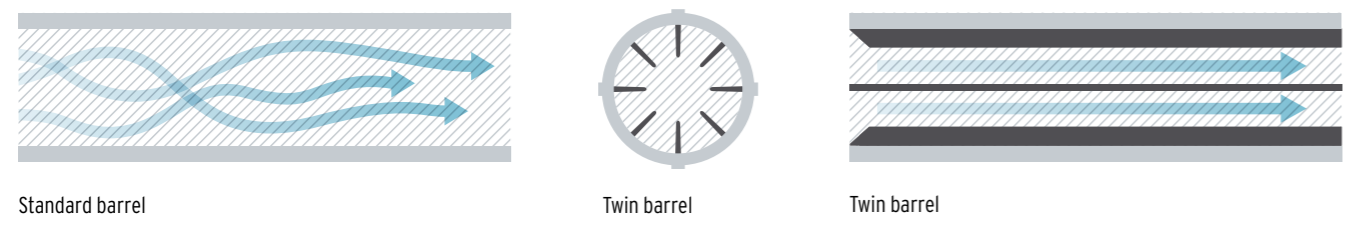

## Nozzle

The particular shape of the nozzle, manufactured with technical polymers, allows the transition from the diameter of the barrel to the diameter defined for the irrigation with the water retaining the maximum velocity and exiting the nozzle with a perfectly round water stream to reach unrivaled throw values.

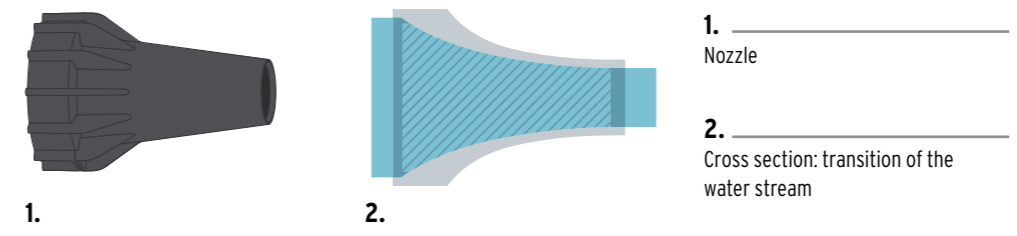

**3** | Energy Efficiency



# 3 Energy efficiency



Pressure greatly determines the operating cost of an irrigation system: the higher the pressure required to operate it, the higher the operating cost will be. What makes the difference is to find a method to limit the operating pressure requirement without sacrificing the quality of the water distribution uniformity.

## Energy System

Due to the use of innovative materials with reduced specific weight and advanced tribological properties combined with the reciprocal calibration of the different components and respective systems, we were able to obtain the optimal performance from the automatic brake and the low inertia drive system. This allows for an efficient operation of the gun in all operating conditions including lower and variable pressure levels.

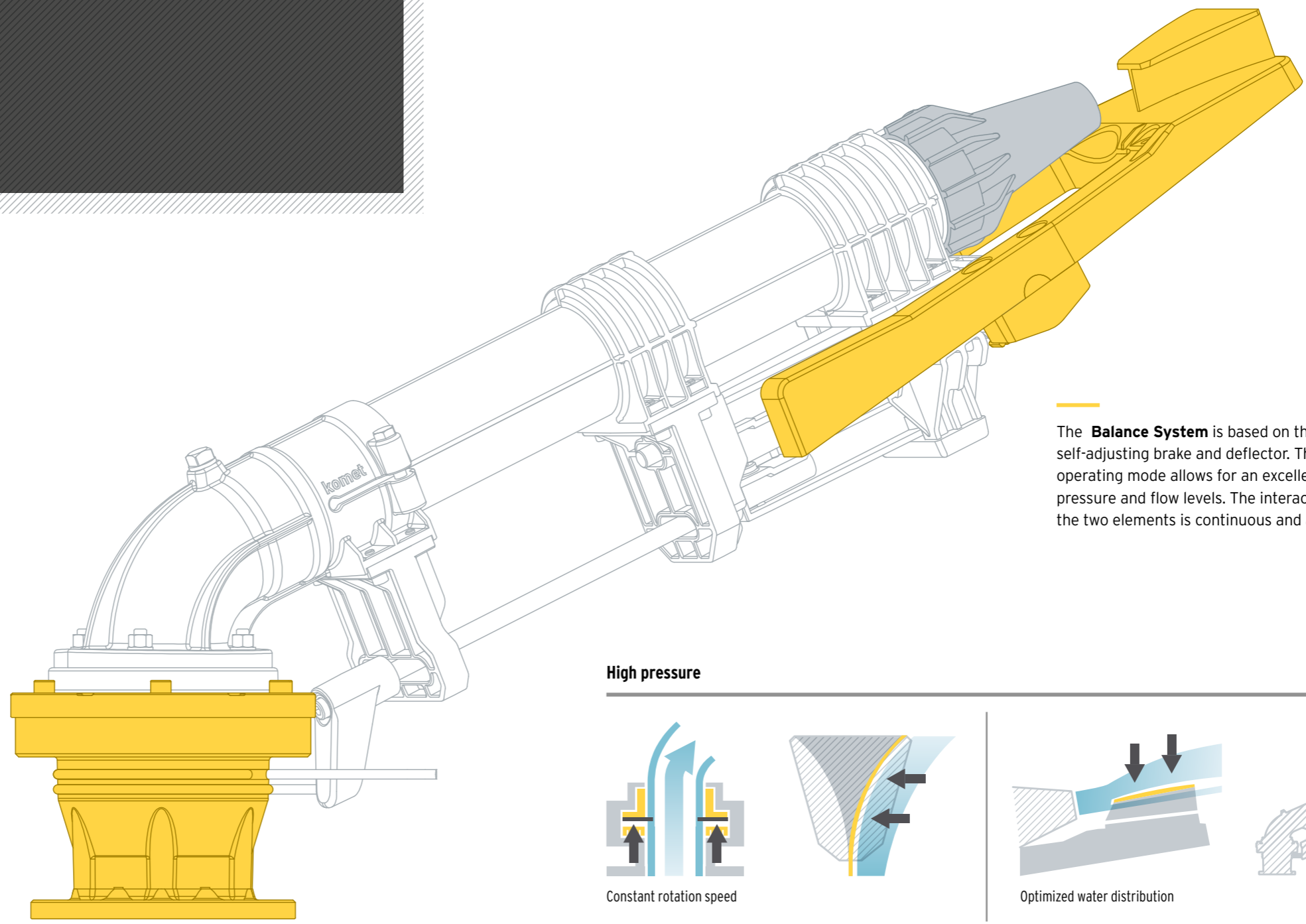

### Low pressure

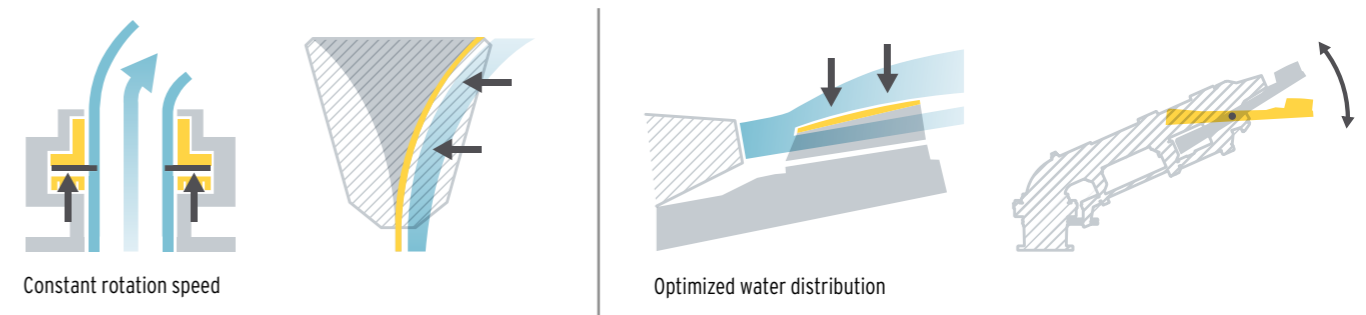

### High pressure

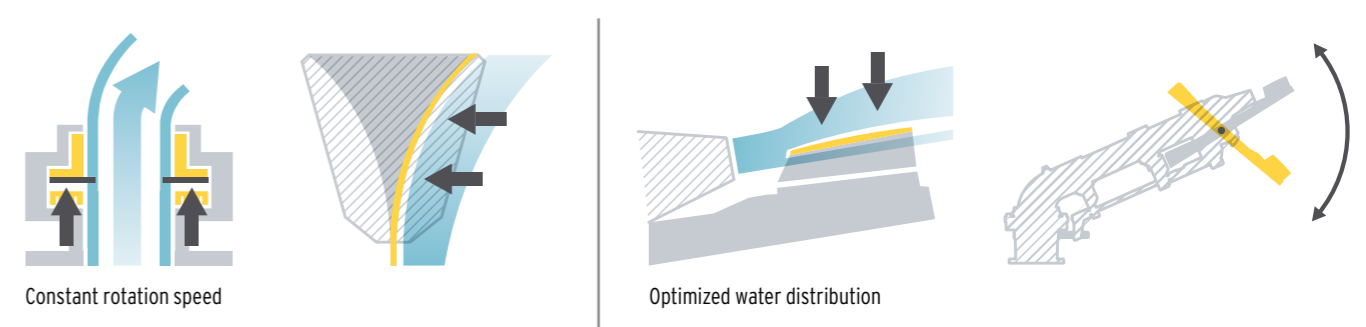

The **Balance System** is based on the interaction between the self-adjusting brake and deflector. The resulting balanced operating mode allows for an excellent performance at all pressure and flow levels. The interactive balancing between the two elements is continuous and automatic.

**4**

**Reliability /  
Fiabilidad**



# 4

## Reliability



It is important that every irrigation system operates reliably in order to avoid yield losses, waste of energy with its associated costs but more than anything to optimize the soil potential. The gun not being continuously monitored, has to operate always at its best without the necessity of adjustments or maintenance.

### Self Control

With changing operating conditions such as pressure and flow the gun self-adjusts all systems in order to allow always for an operation at best efficiency level.



The Automatic Brake System is unique in its function due to the materials used. The internal parts are made of chemically treated stainless steel and inserted into an anodized aluminium housing to increase the resistance to corrosion and wear.

### Design

Reliability is a main concern when designing our products. Each component is developed with the utmost care and the materials are selected to satisfy the requirements of the intended application environment.

### Quality

The precision tooling of every component, the strict quality control during every manufacturing step and the final water test of every single gun are our guarantee of a quality control at its best.



The drive arm mechanism is made of technical polymers that ensure superior performance and excellent resistance to wear, superior to aluminum. The reduced weight of the parts allows for very good operation even at low pressures.

The barrel, made of marine grade aluminum, is designed to maximize throw and optimize distribution. The internal straightening vanes are the result of intense fluid dynamic studies.

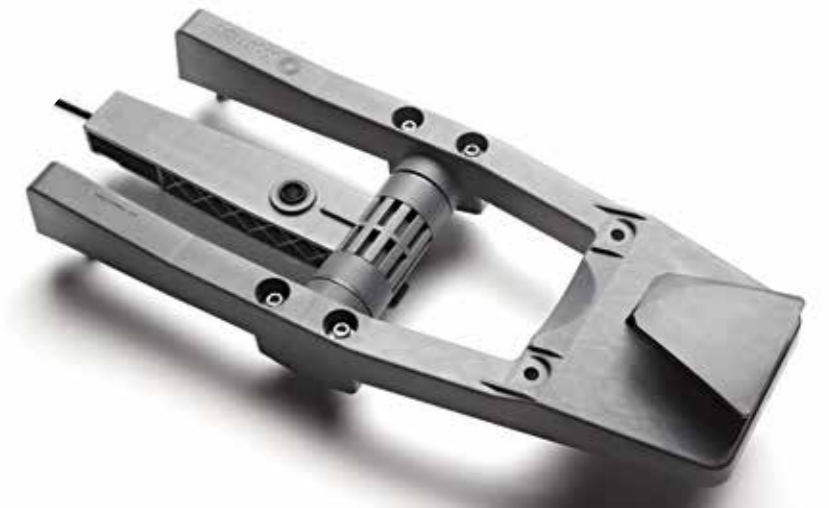

**5**

**Adaptability**



# 5

## Adaptability

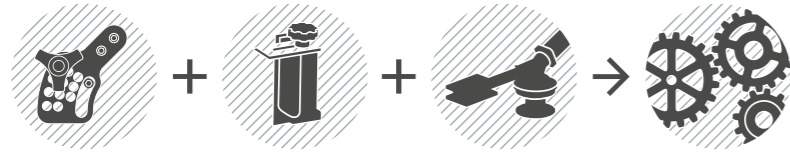

It is fundamental that a gun adapts to every situation while keeping excellent performance in all types of irrigation systems and environmental conditions, also extreme ones.

Es sumamente importante que un aspersor se adapte optimamente a todas las situaciones, para alcanzar la mayor eficiencia posible en los diversos sistemas de riego y circunstancias operativas, aún cuando éstas sean extremas.

### Inverter

Staying within the confines of the field is important for efficient irrigation. Not only does it save valuable resources otherwise lost to adjacent terrain, but can also avoid unnecessary discussions with the neighbours. When the field is adjacent to streets or neighbouring areas, it is common to start irrigation towards the traveller and manually change the irrigation sector afterwards. This procedure can now be automated with the use of the patented Inverter.

The patented Inverter used on travellers, is a time-controlled device to change irrigation sectors while operating. It allows to irrigate two completely independent irrigation sectors which need to be set before starting operation. Starting in the first irrigation sector, the big volume gun will change automatically into the second irrigation sector after a pre-set time has elapsed. If a subsequent full-circle operation is required, a full-circle adapter is available.



### Motion-triggered Timer

The time for the first irrigation sector can be set to a max. of 999 minutes. Once the timer is activated it remains in stand-by mode for 36 hours. Within this time frame the operation can be started at any time. The count-down will start as soon as water runs through the big volume gun and the timer is triggered through motion.



Inverter Timer

### The Inverter is suitable for the following applications:

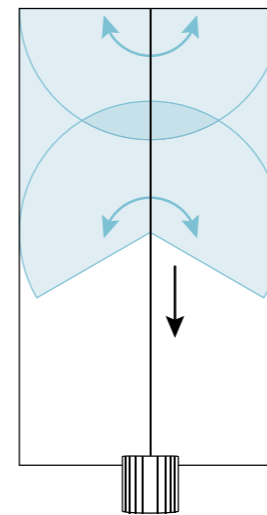

Application "A"

Irrigation with initial inversion of the big volume gun

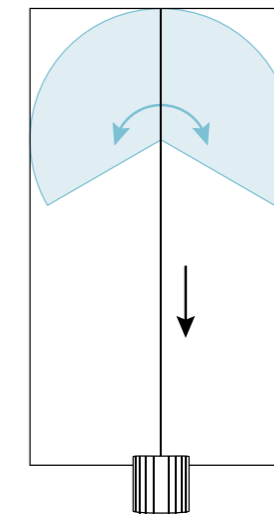

Application "B"

Irrigation with regular retraction of the big volume gun

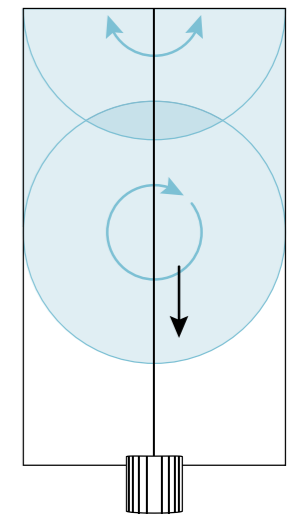

Application "C"

Irrigation with initial inversion and transition to full-circle operation until the end of the irrigation cycle

Twin 160 Ultra with Inverter

First Sector Angle

Second Sector Angle

Timer

Inverter



## Vari-Angle

The adjustment of the trajectory angle without internal flow restriction allows to adapt the irrigation to different climatic conditions including stronger winds. This capability to adjust is a real advantage also in cases where obstacles such as power lines need to be avoid.

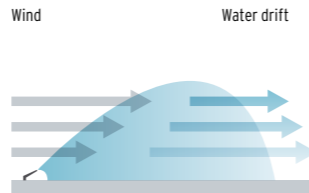

Strong winds can cause substantial water drift.

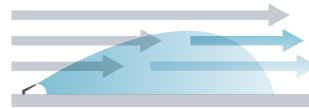

Lowering the trajectory can reduce water drift.

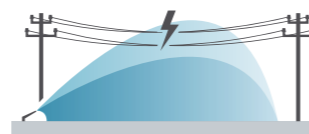

Adjustment of the trajectory in case of power lines.

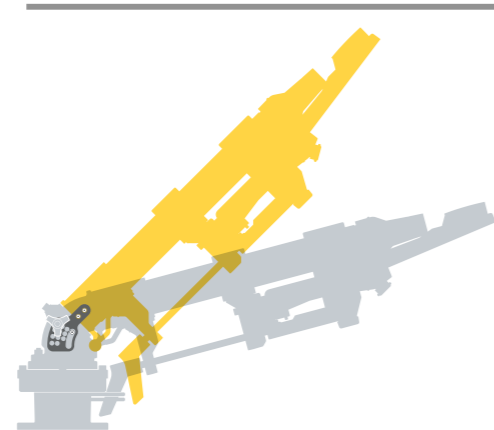

The trajectory angle can be manually adjusted between 15° and 45°.

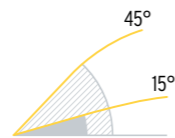

## Transport Lock

If the big volume gun is not adequately secured during transportation of the traveller, the movements can cause serious damage of the big volume gun. A suitable solution is to block the rotation of the big volume gun using the Transport Lock.



Transport Lock  
Twin 101 Ultra / Twin 140 Ultra

Transport Lock  
Twin 160 Ultra / Twin 202 Ultra



Easily installed on top of the big volume gun base, the two different settings of the Transport Lock either permit or prevent the big volume gun from turning. This way it can remain installed also during operation.



## Dynamic Jet-Breaker

The patented working principle of the dynamic jet-breaker allows to redistribute some of the excessive water from the end of the throw typical in low pressure conditions towards the gun. Another important advantage of this device is that it allows to adapt the water distribution profile to suit the requirement of solid-set systems.

### Action of the dynamic jet-breaker

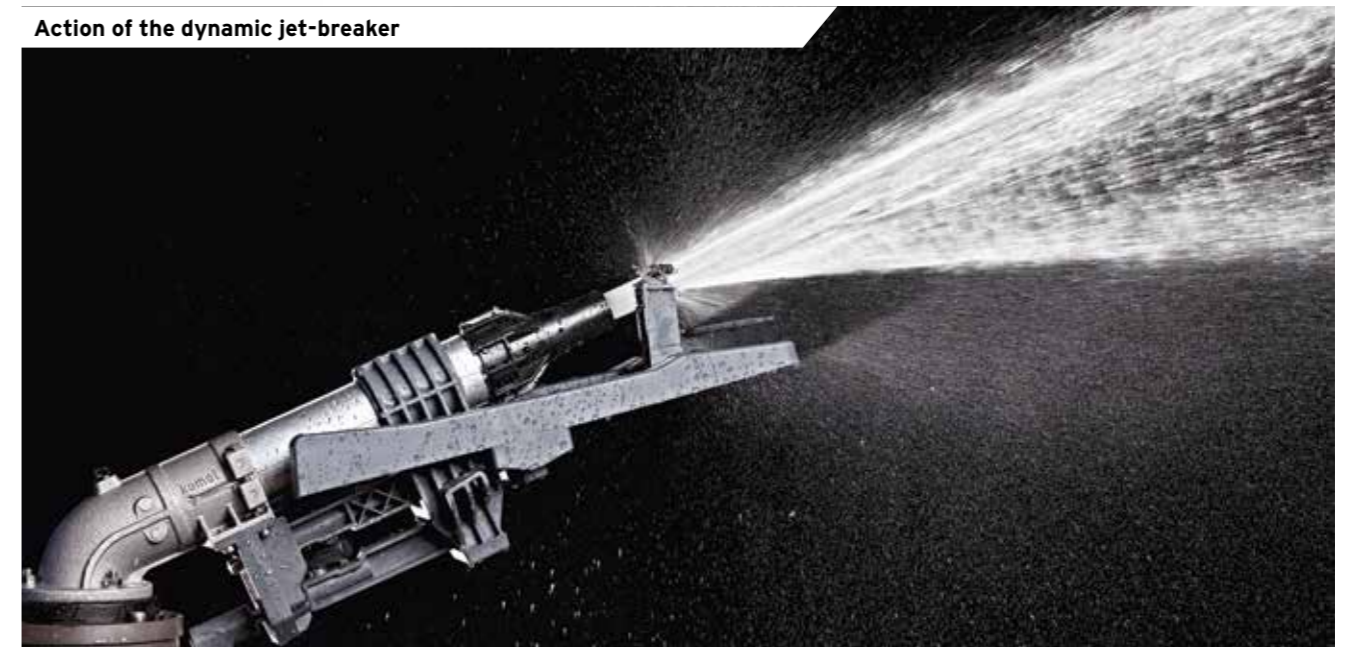

### Effect of the dynamic jet-breaker at low pressures

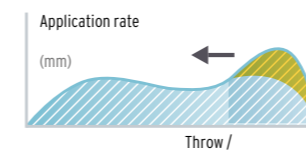

Schematic water distribution profile **without** dynamic jet-breaker

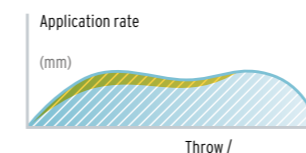

Schematic water distribution profile **with** dynamic jet-breaker

### Effect of the dynamic jet-breaker in solid-set systems

Schematic top view

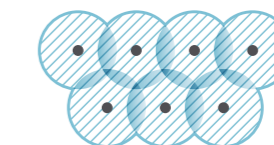

Solid-set system **without** jet-breaker



Solid-set system **with** jet-breaker

## Counterweight

The availability of model specific counterweights allows for smooth operation of the gun on sloping terrain as well as on steep slopes.





Product Configuration



**Twin Max**

**PIVOT 18°**

Fixed trajectory 18°

12 Performance taper bore nozzles

Ø 10-24 mm / 0.39"-0.94"

Part and full circle model

2" Thread



**Twin Max**

**PIVOT 12°**

Fixed trajectory 12°

12 Performance taper bore nozzles

Ø 10-24 mm / 0.39"-0.94"

Part and full circle model

2" Thread



**Twin Max**

**24°**

Fixed trajectory 24°

12 Performance taper bore nozzles

Ø 10-24 mm / 0.39"-0.94"

Part and full circle model

2" Thread

Product Configuration



**Twin 101 ULTRA**

**24° / 21°**

Fixed trajectory 24° / 21°

17 Performance taper bore nozzles

Ø 12-28 mm / 0.47"-1.10"

Part and full circle model

Flange  
2" Thread



**Twin 101 ULTRA**

**PIVOT 18°**

Fixed trajectory 18°

17 Performance taper bore nozzles

Ø 12-28 mm / 0.47"-1.10"

Part and full circle model

2" Thread



**Twin 101 ULTRA**

**FULL CIRCLE**

Fixed trajectory 24°

17 Performance taper bore nozzles

Ø 12-28 mm / 0.47"-1.10"

Full circle model

Flange  
2" Thread



**Twin 101 ULTRA**

**VARI ANGLE**

Adjustable trajectory 15° - 45°

17 Performance taper bore nozzles

Ø 12-28 mm / 0.47"-1.10"

Part and full circle model

Flange  
2" Thread /



**Twin 140 ULTRA**

**24° / 21°**

Fixed trajectory 24° / 21°

19 Performance taper bore nozzles

Ø 16-34 mm / 0.63"-1.34"

Part and full circle model

Flange



**Twin 140 ULTRA**

**VARI ANGLE**

Adjustable trajectory 15° - 45°

19 Performance taper bore nozzles

Ø 16-34 mm / 0.63"-1.34"

Part and full circle model

Flange



**Twin 140 ULTRA**

**INVERTER**

Fixed trajectory 24°

19 Performance taper bore nozzles

Ø 16-34 mm / 0.63"-1.34"

Part and full circle model

Flange



**Twin 160 ULTRA**

**24° / 21°**

Fixed trajectory 24° / 21°

23 Performance taper bore nozzles

Ø 18-40 mm / 0.71"-1.57"

Part and full circle model

Flange



**Twin 160 ULTRA**

**FULL CIRCLE**

Fixed trajectory 24°

23 Performance taper bore nozzles

Ø 18-40 mm / 0.71"-1.57"

Full circle model

Flange



**Twin 160 ULTRA**

**VARI ANGLE**

Adjustable trajectory 15° - 45°

23 Performance taper bore nozzles

Ø 18-40 mm / 0.71"-1.57"

Part and full circle model

Flange /



**Twin 160 ULTRA**

**INVERTER**

Fixed trajectory 24°

23 Performance taper bore nozzles

Ø 18-40 mm / 0.71"-1.57"

Part and full circle model

Flange /



**Twin 202 ULTRA**

**24°**

Fixed trajectory 24°

24 Performance taper bore nozzles

Ø 22-45 mm / 0.87"-1.77"

Part and full circle model

Flange /



**Twin 202 ULTRA**

**VARI ANGLE**

Adjustable trajectory 15° - 45°

24 Performance taper bore nozzles

Ø 22-45 mm / 0.87"-1.77"

Part and full circle model

Flange



**Twin 202 ULTRA**

**INVERTER**

Fixed trajectory 24°

24 Performance taper bore nozzles

Ø 22-45 mm / 0.87"-1.77"

Part and full circle model

Flange

# Quality

**Quality is not invented.  
Quality is a mindset.**

The quality of the product is the essence of our mission. Over the years we have learned that in order to achieve excellence in quality, it is necessary to add the highest levels of technology and innovation to the professionalism of the people involved.

Our manufacturing facility is highly automated. The use of robotic equipment allows us to achieve the highest accuracy and repeatability.

What makes us even more proud is the organizational structure of the company. In many years of development, we have succeeded in creating a perfectly balanced and transparent union between the operating staff and the exploitation of all the potential of our manufacturing equipment. Every detail is cared for. Nothing is left to chance. The result is the capability to offer the market an extraordinarily innovative product with outstanding quality, ensuring unmatched performance and longevity.



**BEVATTNINGSTEKNIK AB**  
Helsingborgsvägen 578, Varalöv  
262 96 ÄNGELHOLM, SWEDEN

Telefon: +46 431 22250  
Email : [info@bevattningsteknik.se](mailto:info@bevattningsteknik.se) eller [philip@bevattningsteknik.se](mailto:philip@bevattningsteknik.se)  
[www.bevattningsteknik.se](http://www.bevattningsteknik.se)